

Gepäckbox	DE	Montage- und Gebrauchsanleitung
Rear box	EN	Installation and usage instructions
Coffre arrière	FR	Instructions de montage et mode d'emploi
Cofres portaequipajes trasero	ES	Instrucciones de montaje y uso
Bagagliera posteriore	IT	Istruzioni di montaggio e d'uso

ULTRA-BOX®



Ultra-Box 320
Ultra-Box 360
Ultra-Box 500



DE Produkstanleitung für
FR Instructions de produit pour
IT Istruzioni prodotto per

EN Product instructions for
ES Instruciones producto para

Code		Description
04147-01-	04148-01-	ULTRA-BOX 320
02801-01-		ULTRA-BOX 360
		ULTRA/BOX 500

DE Verpackungsinhalt
FR Contenu de l'emballage
IT Contenuto dell'imballo

EN Package contents
ES Contenido del embalaje

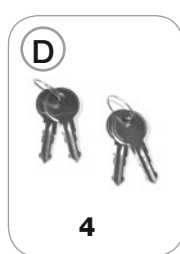
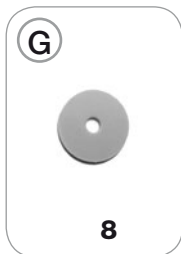
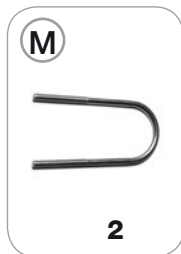

DE Kontrolle bei der Übernahme

EN Goods receipt inspection

FR Contrôle à la réception

ES Control al recibimiento

IT Controllo al ricevimento

DE Bitte kontrollieren Sie, ob alle Einzelteile einwandfrei sind oder eventuell während dem Transport beschädigt wurden. Wenden Sie sich in diesem Falle bitte an den Händler.

EN Check that nothing has been damaged or deformed during transport. In case of damage contact the dealer.

FR Contrôler qu'aucune pièce ne soit cassée ou déformée suite au transport. En cas contraire, contacter le revendeur.

ES Controlar que ningún detalle se haya roto o deformado durante el transporte. En este caso contactar al revendedor.

IT Controllare che nessun particolare sia rotto o deformato a causa di errori di trasporto. In questo caso contattare il rivenditore.

DE Um den Gepäckbox optimal nutzen zu können, lesen Sie bitte die Bedienungsanleitung aufmerksam durch und bewahren Sie sie zur späteren Verwendung gut auf.

EN To use the rear box in the best way, read the user's instructions carefully and keep them on hand for future consultation.

FR Pour tirer le meilleur parti de votre coffre, nous vous invitons à lire attentivement les notices d'emploi et à les conserver pour toute consultation ultérieure.

ES Para usar el cofre en lo mejor de los modos, os invitamos a leer atentamente las instrucciones de uso, guardandolas en caso de necesidad.

IT Per utilizzare al meglio la bagagliera, vi invitiamo a leggere attentamente le istruzioni d'uso e a conservarle in caso di necessità.

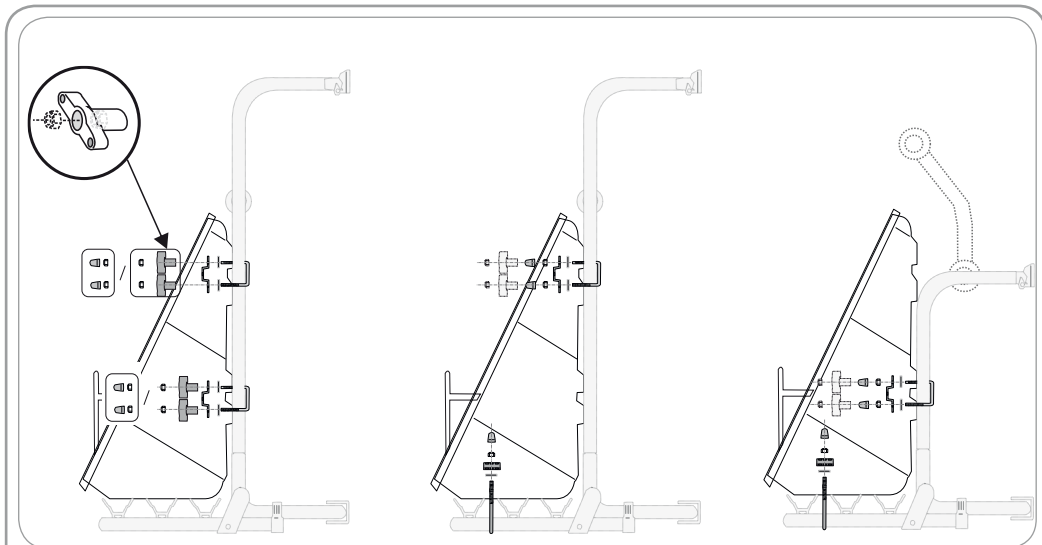

B

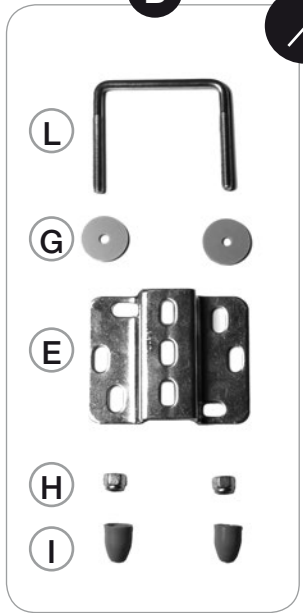

B1

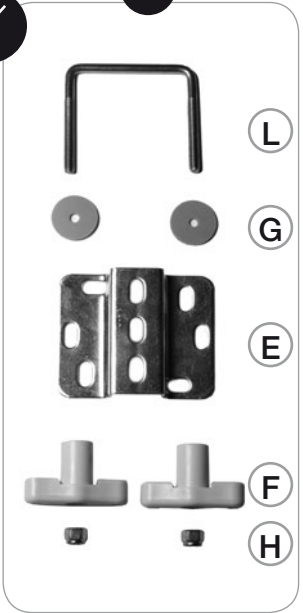

B2

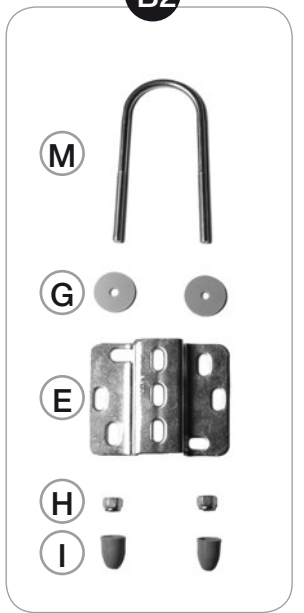

1



2



3



B / B1

4 B

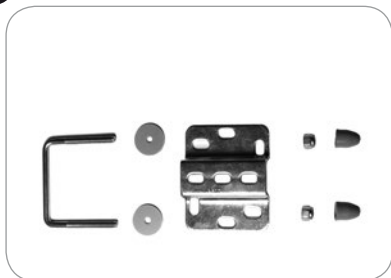

1



2



3



4



5



6

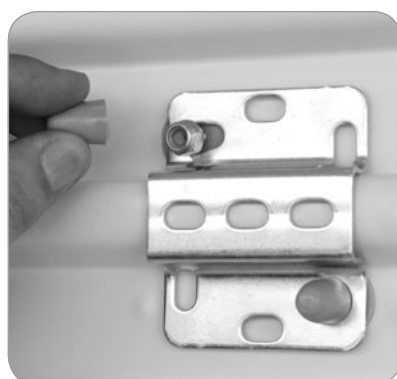

4 B1

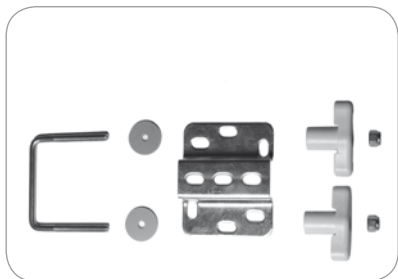

4b



5b



6b



5



4 **B2**

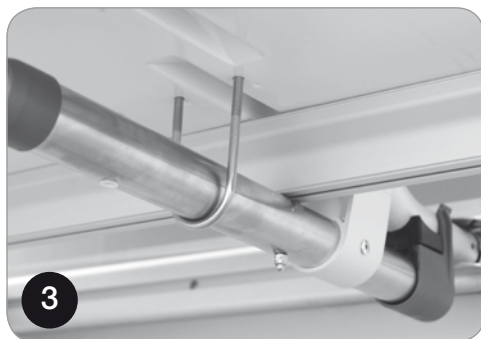
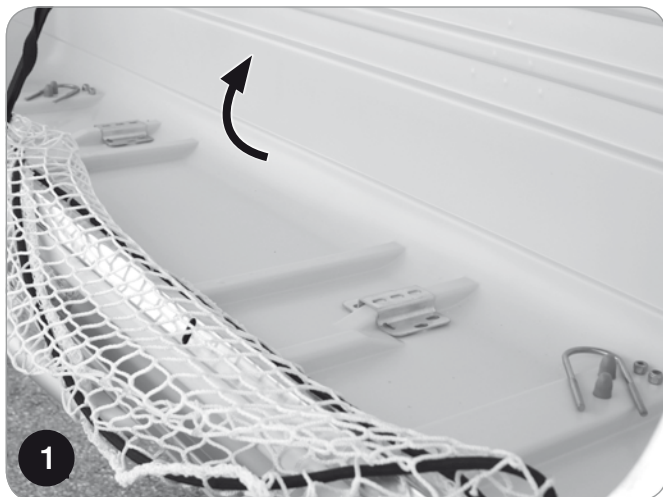
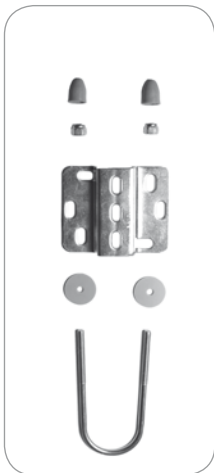

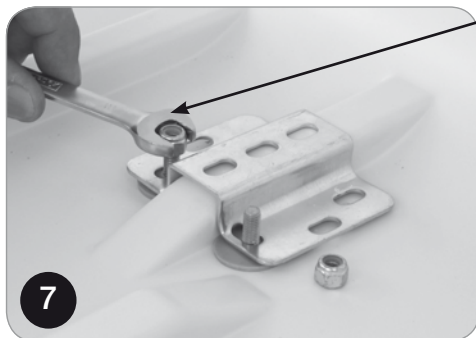

- | | |
|-----------|----------------------|
| DE | Anziehen max 2,5 N |
| EN | Tightening max 2,5 N |
| FR | Serrage max 2,5 N |
| ES | Apriete max 2,5 N |
| IT | Serraggio max 2,5 N |



5



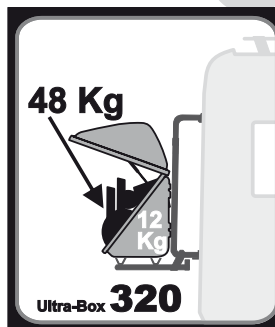
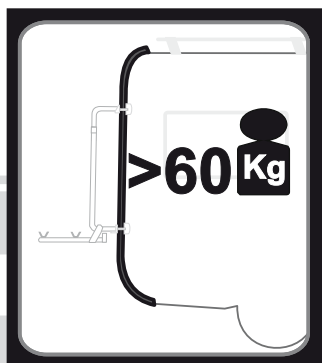

Ultra-Box **320**

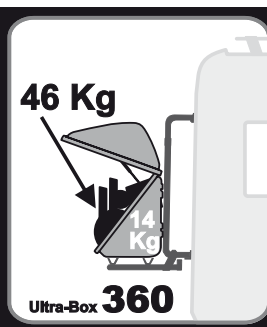

Ultra-Box **360**

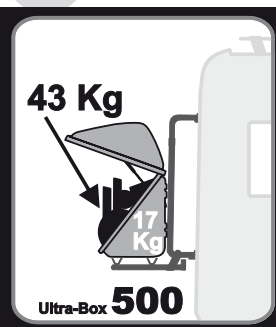

Ultra-Box **500**

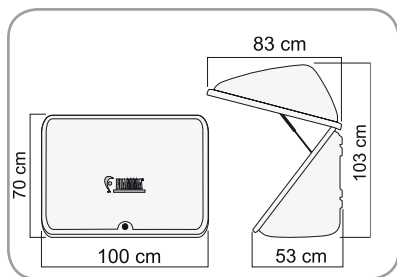

Ultra-Box 320

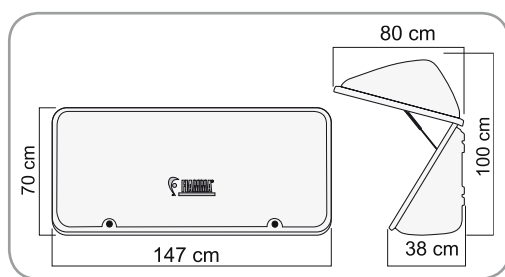

Ultra-Box 360

DE MONTAGE AUF RAIL PREMIUM

EN INSTALLATION ON RAIL PREMIUM

FR MONTAGE SUR RAIL PREMIUM

ES MONTAJE SOBRE RAIL PREMIUM

IT MONTAGGIO SU RAIL PREMIUM

1



2



3

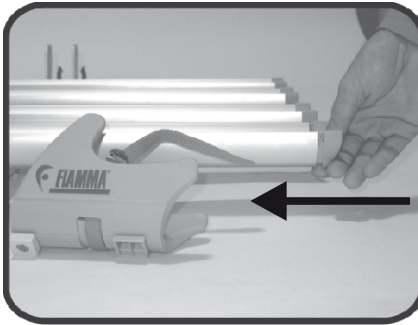

4

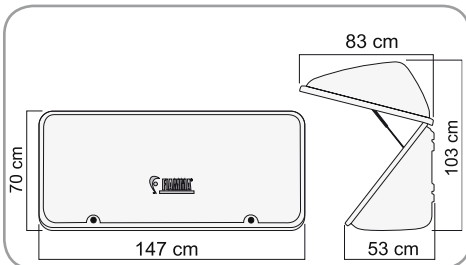
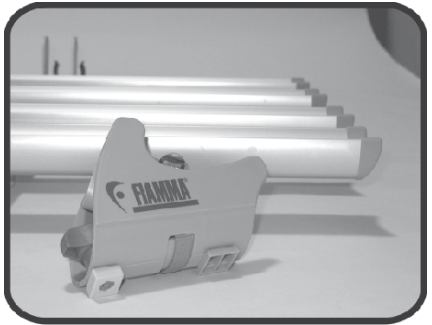

Ultra-Box 500

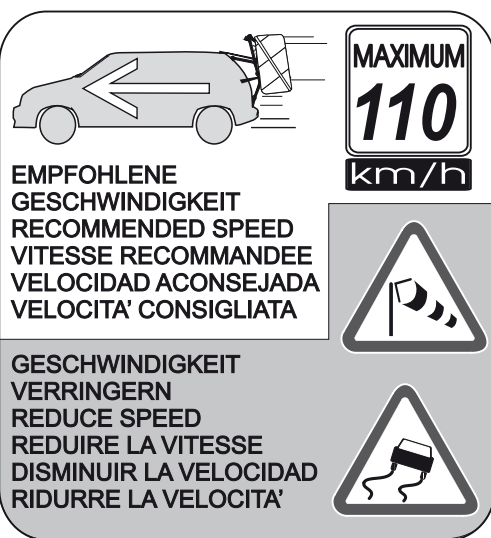
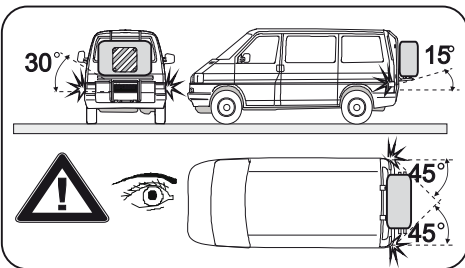
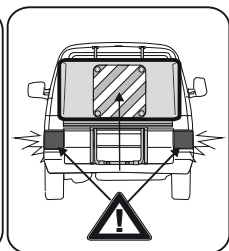
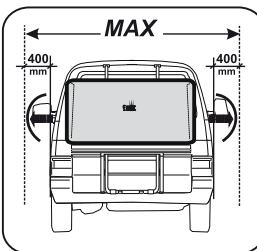
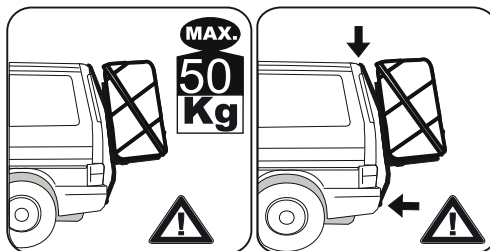

DE Vor Gebrauch bitte überprüfen, dass die Ultra Box nicht verformt oder beschädigt ist.

EN Before using the box, please check there are no breaks or deformations.

FR Avant d'utiliser le coffre, merci de contrôler s'il n'est pas endommagé ou déformé.

ES Antes que usar el cofre, verificar que no sea roto o deformado.

IT Prima di utilizzare la bagagliaia verificare che non sia rotta o deformata.

- Darauf achten, dass der Kofferraum stets geschlossen ist.
- Sicherstellen, dass die Haltebügel dort angebracht sind, wo sie sich nicht quer oder seitlich verschieben können.
Außerdem dürfen sie nicht das Fahrzeugdach, die Scharniere und die dazugehörigen Bolzen oder Schrauben berühren.
- Regelmäßig die Befestigung des Fahrradträgers kontrollieren.
Vor allem nach den ersten 10 km sicherstellen, dass sich die Haltebügel nicht verschoben haben.
- Überprüfen Sie die sichere Befestigung der Fahrräder während der ersten Kilometer.
- Öffnen Sie Ihren Kofferraum nur, wenn der Träger komplett verspannt und nicht beladen ist, ansonsten besteht die Gefahr von Lackschäden.
- NIEMALS DAS NUMMERNSCHILD UND DIE RÜCKLICHTER VERDECKEN
- Wenn der Träger nicht benutzt wird, bitte abnehmen.
- Die Belastung muß gleichmäßig verteilt werden. Darauf achten, dass die Ladung nicht mehr als 400 mm über den äußeren Rand der Begrenzungs- oder Schlussleuchten seitlich hinausragt.
Das veränderte Fahrverhalten des Kraftfahrzeuges (Kurven und Bremsverhalten) bei beladenen Fahrradträgern beachten.
- Auch mit einem weiteren Bremsabstand rechnen.
- In einigen Fällen wird der Gebrauch des Heckscheibenwischers durch den Fahrradträger behindert; daher muß man vor der Inbetriebnahme des Heckscheibenwischers den Aktionsradius des Wischerblattes kontrollieren.
- FIAMMA übernimmt bei Schäden durch falsche Montage, unsachgemäßen Gebrauch, Transport oder ungeeignete Instandhaltung des Fahrradträgers keine Verantwortung.
- Bitte regelmäßig die Befestigungsschrauben kontrollieren.
- Kleine Gepäckstücke sind gegen das Verrutschen in der Box zu sichern.

- Make sure that the luggage compartment is always closed.
- Make sure that the support brackets are located where they cannot move or shift sideways. They also must not touch the roof of the vehicle, the hinges and the corresponding bolts or screws.
- Periodically check the bicycle rack to make sure it is firmly attached, especially after the first 10 km.
- Make sure the belts are not loose and that the holding brackets have not shifted.
- **DO NOT COVER THE NUMBER PLATE OR LIGHTS.**
- In case of long period of disuse, we suggest you unhook the bike carrier.
- The load must be evenly distributed and must not exceed the maximum width of the vehicle.
- Be careful when driving and beware of gusts of wind. Also keep in mind that you need a longer braking distance.
- In some cases, the bicycle rack interferes with the rear windscreen wiper use. Examine carefully the brush radius before turning on the rear wiper.
- FIAMMA is not liable for damages arising from non-observance of the laws in force, the installation, carriage and maintenance instructions or from incorrect use of the bike carrier.
- Check periodically the whole assembly and that the nuts are still well fixed.
- Fix small items properly in order to avoid any movement.

- Faire attention que le coffre soit toujours fermé.
- S'assurer que les supports de tenue soient positionnés dans des zones où aucun transfert ou aucun déplacement latéral ne soient possibles.
De plus, ils ne doivent pas toucher le toit de la voiture, les charnières, les boulons et les vis correspondants.
- Contrôler périodiquement l'état de fixation du porte-vélos surtout après les 10 premiers kilomètres en s'assurant que les supports de fixation n'aient pas bougé.
- S'assurer que les fixations des vélos soient fermes: pendant le voyage, après un bref parcours, s'arrêter pour en vérifier la stabilité.
- **NE PAS CACHER LA PLAQUE OU LES FEUX.**
- Si le porte - vélos doit rester inutilisé pendant une longue période, nous vous conseillons de le décrocher.
- Le chargement doit être distribué d'une façon homogène et il ne doit pas dépasser la largeur maximum du véhicule.
- Pendant les voyages faire attention aux tournants et aux vents latéraux.
En plus calculez une distance de freinage supérieure.
- Dans certains cas le fonctionnement de l'essuie-glace arrière est gêné par le porte-vélos; faire attention au rayon d'action du balai avant d'actionner l'essuie-glace.
- FIAMMA ne répond pas des dommages, dans le cas où les indications des lois en vigueur, concernant l'installation, le transport ou l'entretien ne seraient pas respectés ou en cas d'emploi impropre du porte-vélos.
- Vérifiez périodiquement que les écrous soient bien serrés et que le montage soit sûr.
- Fixez convenablement les petits objets à l'intérieur du coffre pour éviter qu'ils ne se déplacent pendant le trajet.

- Poner cuidado con que el cofre portaequipajes esté siempre cerrado.
- Asegurarse de que los estribos de fijación estén en una correcta posición y en un lugar sin posibilidad de desplazamientos laterales; además no tienen que tocar el techo del vehículo, las bisagras y los correspondientes pernos o tornillos.
- En unos casos el uso del limpiaparabrisas es impedido por los portabicicletas, poner cuidado con el rayo de acción del cepillo antes que accionar el limpiaparabrisas.
- Controlar periódicamente el estado de fijación de los portabicicletas sobre todo después de los primeros 10 Km, asegurándose de que los estribos no se hayan movidos.
- **NO CUBRIR NI LA MATRICULA NI LAS LUCES.**
- En caso de que no se use, les rogamos desganchar el Carry-Bike del vehículo.
- El cargo tiene que estar distribuido uniformemente y no tiene que superar la anchura máxima del vehículo.
- Durante la conducción del vehículo poner mucho cuidado con las curvas y con los golpes de viento. Además tenemos que poner mayor cuidado con la distancia de frenazo.
- Fiamma no responde a daños por falta de respeto de las normas vigentes, de las indicaciones de instalación, transporte, mantenimiento o uso impropios, que es responsabilidad del adquirente.
- Controlar periódicamente la fijación de los tornillos.
- Fijar los objetos de tamaños pequeños para evitar que se muevan dentro del cofre.

- Fare molta attenzione che la bagagliaia sia sempre chiusa.
- Assicurarsi che le staffe di tenuta siano posizionate in zone dove non è concessa nessuna traslazione o spostamento laterale; inoltre non devono toccare il tetto dell'autovettura, le cerniere e i relativi bulloni o viti.
- In alcuni casi l'uso del tergilunotto è ostacolato dal portabiciclette, fare molta attenzione al raggio d'azione della spazzola prima di azionare il tergilunotto.
- Controllare periodicamente lo stato di fissaggio del portabiciclette soprattutto dopo i primi 10 Km assicurandosi che le staffe di fissaggio non si siano mosse.
- **NON COPRIRE LA TARGA E LE LUCI**
- In caso di non utilizzo, si prega di sganciare il portabiciclette.
- Il carico deve essere distribuito omogeneamente e non deve oltrepassare la larghezza massima del mezzo.
- Durante la guida prestare maggiore attenzione ai tornanti ed ai colpi di vento. Inoltre tenere conto di una distanza di frenata maggiore.
- La FIAMMA non risponde di danni per mancato rispetto delle vigenti leggi, delle indicazioni di installazione, trasporto, manutenzione o uso improprio, che è responsabilità dell'acquirente.
- Controllare periodicamente il fissaggio delle viterie.
- Fissare gli oggetti di dimensioni ridotte per evitare che si muovano all'interno della bagagliaia.

DE Im Falle einer Vertragswidrigkeit der Ware, kann der Verbraucher unter den erforderlichen Voraussetzungen gegenüber dem Verkäufer von dem Garantieanspruch zu den festgelegten Bedingungen gemäss den lokalen Rechtsvorschriften Gebrauch machen.

EN In case of defects with regards to materials and manufacturing, the customer is entitled to the warranty in accordance with local laws and regulations of the country in which the product was purchased.

FR En cas d'un défaut de conformité du produit, le consommateur pourra faire valoir ses droits de recours en garantie selon les modalités prévues par les dispositions légales locales, pour autant que les conditions de recours soient remplies.

ES En caso de fallos o defectos de material y de fabricación, el cliente puede hacer valer la garantía de acuerdo con las leyes y reglamentaciones del país en el que el producto haya sido comprado.

IT In caso di difetto di conformità dei beni, il consumatore potrà far valere nei confronti del venditore la garanzia secondo le modalità previste dalle disposizioni di legge locali, ove ne ricorrano i presupposti.

05511-01-

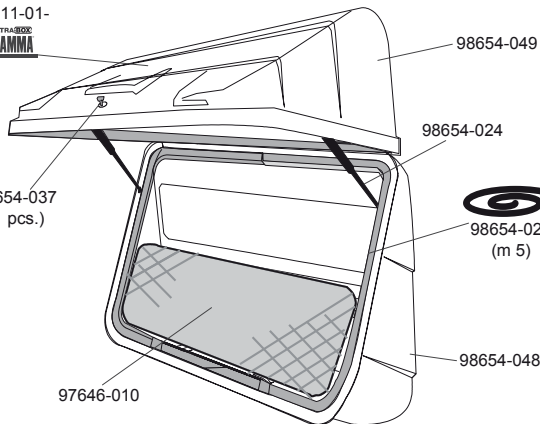

Ultra-Box 320

98654-010

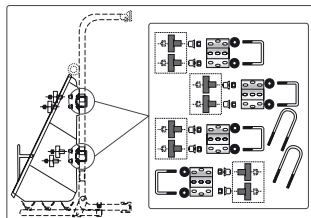

98654-037

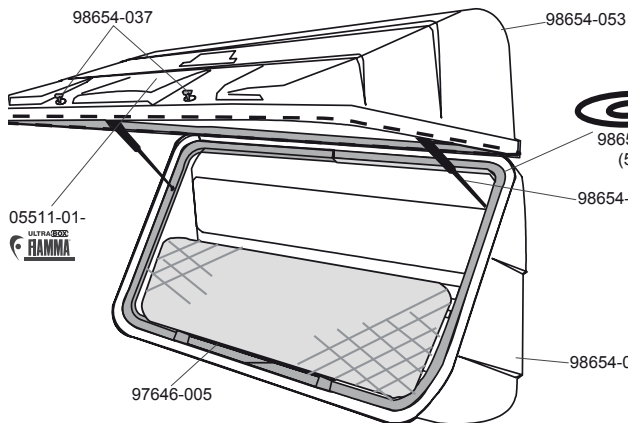

Ultra-Box 360

98654-010

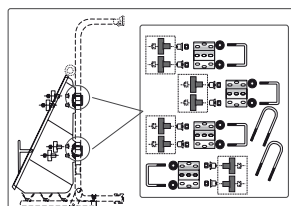

05511-01-

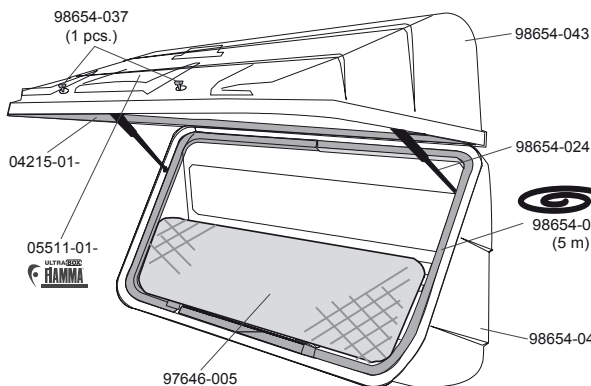

Ultra-Box 500

98654-010

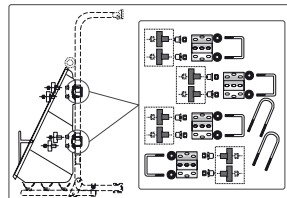



fiamma.com

All rights reserved.

Fiamma S.p.A. reserves the right to modify at any time, without notice, prices, materials, specifications and models or to cease production of any model.

ULTRA-BOX 320
04147-01-

ULTRA-BOX 360
02801-01-

ULTRA-BOX 500
04148-01-

D0_IS_98690-024_revS

Carry-Bike

Fiamma SpA - Italy
Via San Rocco, 56
21010 Cardano al Campo (VA)